

Power Tillers

# EL Series



[www.KuhnNorthAmerica.com](http://www.KuhnNorthAmerica.com)



**Invest in Quality®**

POWER TILLERS EL SERIES

# INTENSIVE TILLAGE FOR BETTER RESULTS IN HEAVY SOILS

For over 50 years Kuhn has been perfecting the rotary power tiller while always focusing on giving producers, from homeowners to large commercial farms, the best ROI (Return on Investment) possible.

## BUILT TO PERFORM

This goal is accomplished through the use of high quality materials, innovative and durable designs, and an extensive application of earned agronomic knowledge.

## AN EXCELLENT MIXTURE TO HELP YOU REACH SUCCESS

Incorporating residue, enhancing soil structure, improving subsequent root development, if one or more of these are goals you want to accomplish, a Kuhn power tiller is your solution.

## POWER TILLERS EL Series in brief:

Series	Working width	Maximum Working Depth	Max PTO (hp)
EL 23	4'1" – 4'9"	4"	25
EL 43	3'6" – 6'2"	6"	40
EL 53	3'2" – 6'2"	6"	50
EL 62	4'2" – 6'11"	7"	65
EL 82	4'3" – 6'9"	9"	85
EL 92	5'11" – 7'7"	9"	100
EL 122	8'2" – 9'10"	9"	125
EL 162	8'2" – 9'10"	10"	165
EL 282	9'10" – 15'	11"	270





# MULTI-PURPOSE TOOLS

for

# MULTI-PURPOSE USES

Kuhn power tillers are highly versatile and well adapted for use in crop farming, land reclamation and vegetable production. They work the soil intensively and perform in virtually all conditions, especially in heavy soil or rocky conditions. One pass is usually sufficient to create a well prepared seedbed. In combination with an integrated seed drill, seeding can be carried out at the same time.



## IMPROVE YOUR SOIL

Blades work the soil and eject it against the hood. This way it is effectively loosened, crumbled and mixed together. Kuhn power tillers are designed for intensive soil loosening and breaking up of dirt clods. The work intensity depends on the rotor speed, the tool type and forward travel speed. A general rule of thumb is the slower you work with the tiller, the quicker the rotor shaft turns giving you a more fine and crumbled soil mixture. It's important not to exaggerate this, as the soil's natural crumble structure might be damaged.



## 1. FAST DECOMPOSITION OF RESIDUES

Rotor tillers mix superficial residues with the soil and loosen it to let air in. This way harvest residues, cover crops or the grass root system are rapidly decomposed.

## 2. BREAKING UP PASTURES

The tiller blades also cut and mix heavily rooted soil effectively, making it a perfect tool for breaking up pastures or former conservation land.

# HIGH QUALITY TILLING WITH MINIMAL MAINTENANCE



## CUT AND INCORPORATE PLANT DEBRIS

This includes field cutting annual shoots, incorporating mulch and cover plants into the soil or to plow up a permanent vegetation cover. The Cultirator (C-blades) of Kuhn power tillers provide exceptional cutting of plant material and provide a better overall structure before working it into the soil.

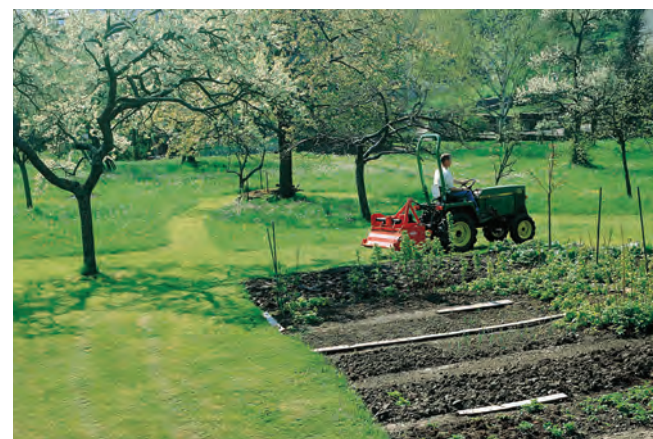

## NO CHANCE FOR WEEDS

During the vegetation period, weeds compete for nutrients and water with vines and fruit trees. Spring or summer tillage with power tillers constitutes an environmentally friendly alternative to chemical control. Soil organisms are replenished with the nutrients they need, while the weeds are permanently weakened.

Designed with the same precision and attention to detail as Kuhn's large professional grade tillers, the EL 23 addresses the particular demands of smaller tillers including:

- High-quality tilling producing a smooth and clean finish, ready for planting or seeding
- Minimal maintenance with no oil changes or chain tension adjustment required
- Easy access to hitch points when attaching or detaching from the tractor



### MINIMAL MAINTENANCE

The design of the drivetrain eliminates the need for periodic maintenance. Use of semi-fluid grease in the central gearbox and an automatic slack adjuster provides:

- No need for oil changes
- No chain tension adjustment

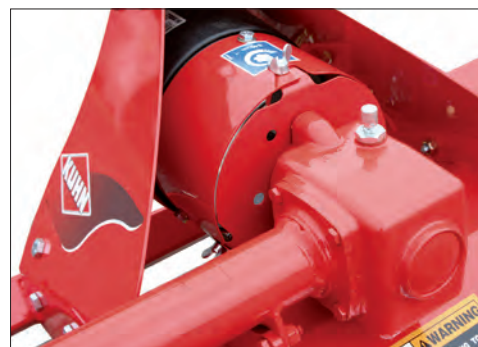

### EASY ACCESS

The PTO cross, points and slip clutch are easily accessible. Access to grease the PTO cross is accomplished by loosening a few wing nuts and pulling the guard forward.



### HIGH CLEARANCE ROTOR

The rotor and hood design maximizes the efficiency of smaller tractors. Soil and clods flow freely to effectively work the ground without producing unnecessary drag that robs horsepower from the tractor. The solid steel rotor shaft is fitted with high quality steel blades specifically designed to work in varying conditions including vegetation and organic materials.



# DURABLE AND RELIABLE

A versatile tool is what farmers expect when buying a power tiller. Kuhn power tillers meet these needs while mastering difficult soils and dealing with the presence of rocks without any long term impact on the machine.

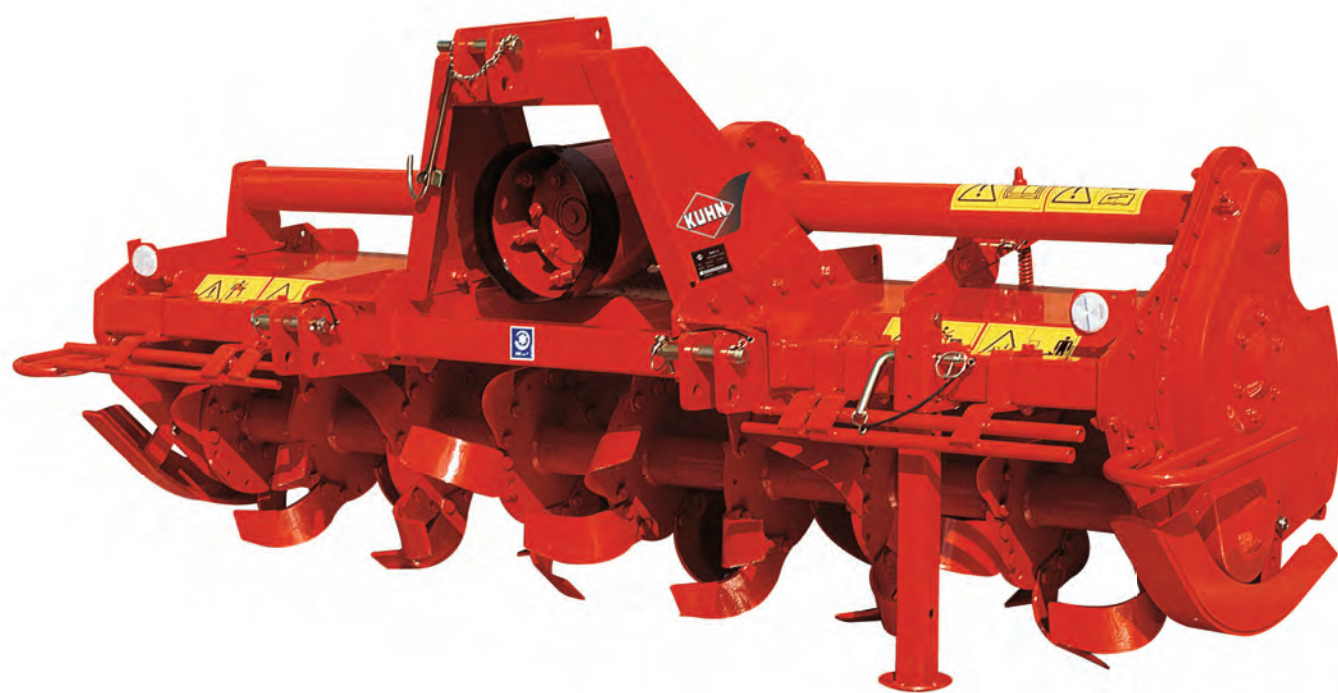

## BUILT TO LAST HEAVY-DUTY FRAME

The EL 62, 82 and 92 are grouped together by a large frame providing high rigidity and exceptional endurance. The front portion is integrated with the casing, increasing the machine's strength and giving you the potential to attach other equipment if needed.

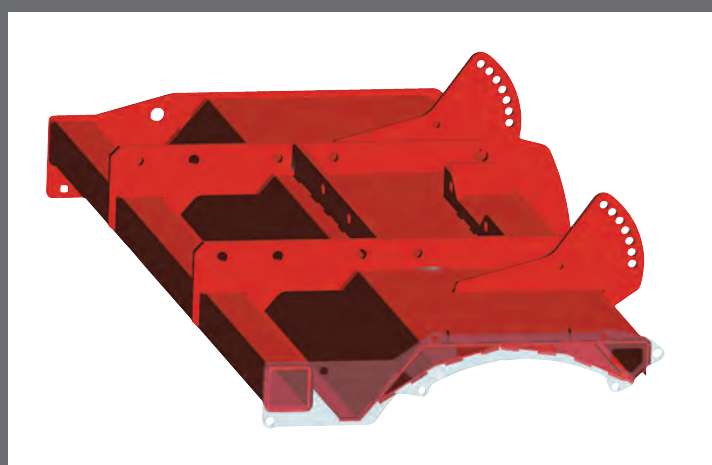

## ROTOR DRIVE Optimum operating performance

Reliable and safe with very little maintenance needed. What else would you expect from a Kuhn tiller?



### EL 43/53: LONG SERVICE LIFE

The rotor is driven by tempered steel sprockets, located in a side case with thick walls on the EL 53. The oversized chain with automatic tension adjustment is much more resistant to fatigue than competitive models. The drive chain is immersed in an oil bath for consistent lubrication.

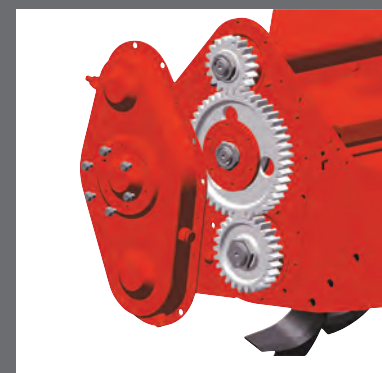

### EL 62/82/92: HIGH-DRIVE CAPACITY

On the larger EL models the rotor is driven by case hardened, forged steel gears, which are mounted on conical or double row roller bearings for maximum capacity. They run in an oil bath. The heavy-duty sealing of the lower gearcase is fitted with a metallic face seal, which provides the highest possible resistance to leaking and contamination in abrasive soil conditions.

## CENTRAL GEARBOX Rugged yet refined

### EL 43/53: REDUCED ANGLES FOR INCREASED SERVICE LIFE

The central cast iron gearbox of the smaller models is mounted directly on the tiller frame with hardened forged steel gears that run in an oil bath. It can be offset with the 3-point frame to avoid an awkward angle on the transmission. This allows it to work easily under trees and on field edges. The drive is protected as standard by a friction slip clutch.



### EL 62/82/92: ALL THE BASICS WITH EVEN MORE VERSATILITY

On the bigger models, the central gearbox is cast iron and set back for reduced PTO angles. A friction slip clutch is standard for protection of the drivetrain. The EL 62 Duplex gearbox offers two speeds by inverting the gears. The Duplex gearbox with two speeds is standard on the EL 92. Two additional speeds are available as optional equipment, offering the adaptation capability to various working conditions.



# PROVIDING HIGH WORK QUALITY AND VERSATILITY

Kuhn power tillers for vineyards and orchards are versatile tools, answering the various needs and requirements of vineyards, market gardeners, horticulturists, etc. With their sophisticated features, they provide exceptional work quality and efficiency in a wide range of conditions.



SERIES	MODEL	OFFSET
EL 43	105 / 130 / 150	8" / 12" / 16"
	190	fixed
EL 53	100 / 130 / 155	6" / 12" / 12"
	190	fixed
EL 62	130 / 155 / 165 / 180	8"
	210	fixed
EL 82	130 / 155 / 180	8"
	205	fixed
EL 92	180	4"
	205 / 230	fixed

## REAR HOOD

A match for all conditions

The rear hood of EL tillers is ideally shaped for uniform soil flow and adaptable to various conditions: shallow or deep tillage, dry or wet soil and different quantities of plant residues. You can now adapt the hood to fit your needs.

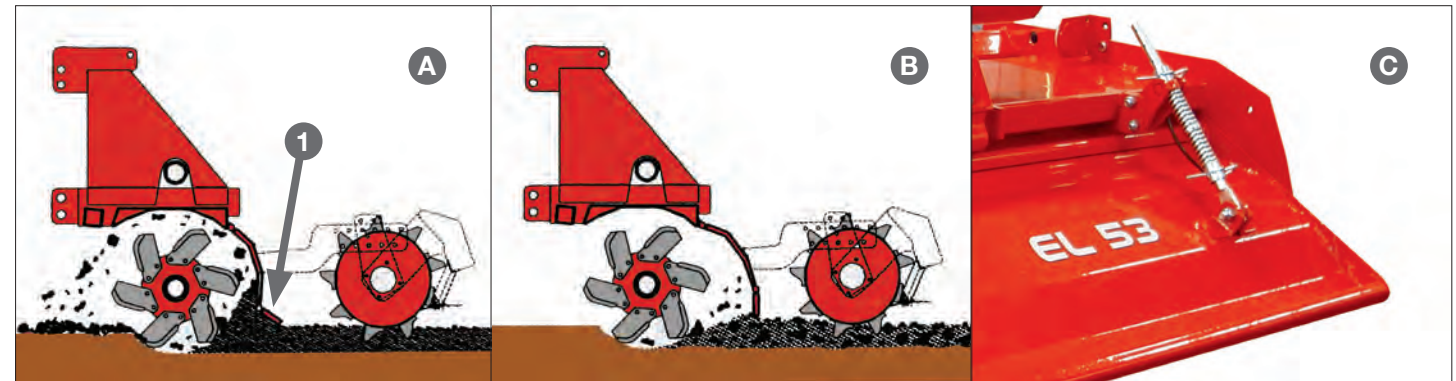

### HOW MUCH CRUMBLING AND LEVELING? YOUR CHOICE!

If the rear hood is positioned close to the rotor **A**, it accumulates soil until the latter is recycled to the front, which results in a high crumbling degree. In wet conditions or in plant residues, the machine will cope better with a more open rear hood **B**. Even more efficiency is provided with the leveling extension available on EL 62, 82 and 92 **1**. The rear hood is spring-loaded **C** for optimal seedbed preparation where additional firming and leveling is needed.

### SIMPLE ADJUSTMENTS

Adjusting the rear hood is quick and easy. By checking the chains on the EL 43 and pins on EL 53 to 92. The leveling extensions of the bigger models are easily adjustable by pins.

## THE KUHN PLUS: A COMPACT DESIGN

All Kuhn power tillers for vineyards and orchards are a very compact design for efficient operations in narrow rows. While the EL 43 is additionally known for its exceptionally low profile for passing safely under overhanging branches, it is the small overall width-to-working width ratio of the EL 62, 82 and 92, that particularly shines. Moreover, the rounded hood edges and skids protect plants from being damaged.



### PROGRESSIVE LATERAL OFFSET

Offset hitch capability normally allows a tiller that is narrower than the tractor to erase the tractor wheel track on its right side. Offsetting the hitch is easily accomplished by sliding the three yokes of the tiller frame. Thanks to this continuous manual offset the machine can be adapted according to the situation and ensure perfect stability.

### C-BLADES FOR OPTIMUM TILLAGE

The special curved design of Kuhn tiller blades have been tested and optimized for:

- Chopping and mixing of plant residues
- Aggressive cutting into hard soil while requiring less horsepower
- Increased crumbling of soil clods

The EL 43 is fitted with four blades per flange as standard (six as an option), while all other models possess six for even more efficient crumbling. For shallow work, L-blades can be fitted on the EL 53 to EL 92 models.

# COMPACT TOOL FOR GARDENS, GREENHOUSES AND LANDSCAPE

The EL 43 power tiller is an adaptable tool and suitable for various tasks. It has been designed for seedbed preparation, gardening, greenhouse operations and landscape maintenance. It is particularly suited for compact and small tractors from 15 to 40 horsepower.



# FLEXIBILITY TO MEET ALL KINDS OF SOIL PREPARATION

Designed for operation in demanding environments on tractors with greater horsepower. Greenhouse operators, landscapers and large food plot producers who demand the most from a tiller will find peace of mind with the EL 53. Built considerably heavier than the EL 43, it is the ideal tool for various operators to use as they begin to prepare soil for planting.



## WORKING DEPTH CONTROL: CHOOSE BASED ON YOUR NEEDS

All EL 43 power tillers are fitted as standard with easily adjustable depth control skids ①. Where necessary, optional depth control wheels are available ②. The wheels are standard on EL 53 tillers. Optional skids ③ or heavy-duty wheels ④ with a larger diameter and a more powerful wheel column are available as an option for the EL 53. No restrictions from easy operations to more demanding applications!

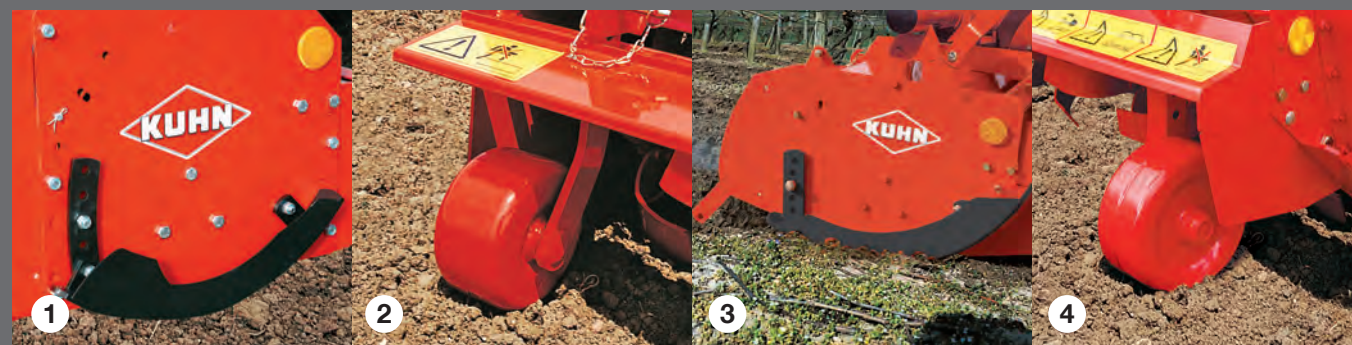

### LANDSCAPE DESIGNS AND MORE

The compact design and low profile of the EL 43 power tiller allows the tiller to work safely under overhanging branches and close to greenhouses.

### QUICK HITCH COMPATIBLE

With the optional adapter, the hitch on the EL 43 and 53 are compatible with a Cat. 1 Quick Hitch for faster attachment and removal.



POWER TILLERS EL 62 / 82 / 92

# THE SPECIALTY CROP WORKHORSE

The EL 62, 82 and 92 Kuhn power tillers are the result of a long experience in soil preparation and decades of research and development. Particular care has been given to the following fundamental criteria:

- A design for demanding vineyard, market garden, horticulture and tree nursery professionals
- A high level of versatility and adaptability
- Simple adjustments enabling fast adaptation to all situations
- High reliability and long life for continued peace of mind

## MULTIPLE HIGHLIGHTS

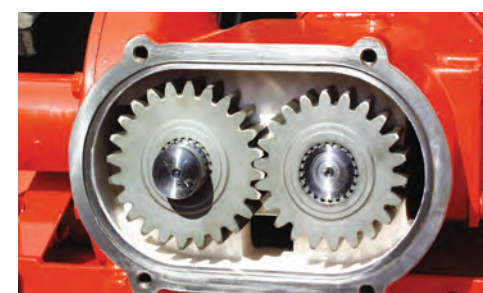

### GREAT DURABILITY

Rotor drive is constructed with case-hardened forged, steel-gears. The main frame is built from a large box section casing.



### COMPACT DESIGN COMBINED WITH VERSATILITY

Small overall working width ratio – continuous lateral offset attachment on EL 62 – for vineyards, market gardens, horticulture and tree nurseries.



### HIGH WORK QUALITY UNDER ALL CONDITIONS

Optimized design of rear hood – rear hood adjustable for changing work intensity – C-blades for optimum tillage and plant residue handling.



# EFFICIENCY – VERSATILITY – ADAPTABILITY

## OPTIONAL EQUIPMENT: MULTIPLE POSSIBILITIES



**SIDE SEPARATING DISCS**  
Avoid ridge formation between two passes and facilitate work in long plant residues. Easily adjustable by a pin.



**TRACK ERADICATORS**  
Loosen the soil behind tractor wheels. Made up of four flexible tines adjustable in height and distance.



**SIGNALING EQUIPMENT**  
This replaces the tractor's signaling when covered by the power tiller.

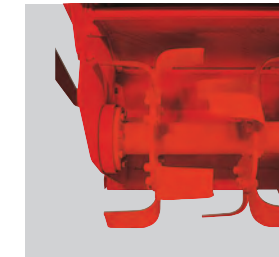

**L-BLADES**  
For shallow cultivation and reducing weeds, the rotor can be fitted with L-blades.



**COUNTER FLANGES**  
EL 92 power tillers can be fitted with counter flanges for reinforced blade hold in rocky conditions.

## DEPTH CONTROL: MULTIPLE CHOICES

On all models, working depth is controlled by using skids **1** or wheels **2**. On the EL 82-180, 205 and all EL 92's, rollers are available as an option:

- Crumbler rollers **3** with a large diameter of 15" with removable bars
- Packer rollers **4** with a diameter of 19" are recommended for very wet conditions or clayey soils



# A ROTOR TO MATCH YOUR CULTIVATION METHOD

The unmatched versatility of Kuhn power tillers comes with a wide choice of tools for different tillage applications, production systems or crop residue incorporation.

## CULTIROTOR (C-BLADE): Efficient residue mixing



- Incorporation of cover crops and crop residues
- Plowing up of pastures and old forage crop ground
- Multi-purpose applications for large farms

The C-blade is equipped with curved blades efficient at mixing while producing a uniform finish. The six blades per flange offer good soil engagement and reduced power consumption. The blades are attached to the rotor using counter flanges for increased resistance in hard and rocky soil. "L" blades are optional and available through the Kuhn Parts Department ("C" blades are standard).

## CULTILOW: Increased blade numbers for maximized crumbling



- Secondary tillage of hard, dry clay soils
- Seedbed preparation in min-till applications
- Reduces formation of "plow pans"
- Fine seedbed preparation for spring-sown crops

The high density and trailing blade position of the Cultilow rotor maximizes the crumbling and reduction of soil clods while limiting the risks of clogging the rotor. The left and right angles of the blades provide good soil leveling by moving soil side-to-side.

## CULTITILLER: Straight blades for maximum effect



- Secondary tillage applications
- Min-till primary tillage
- For rocky conditions
- Reduces formation of "plow pans"
- Incorporation of short crop residues

The leading tine position of the Cultitiller rotor lifts and cuts. Alternately left and right angled tines provide good soil leveling by moving soil side-to-side. With 40% less blades than the Cultilow, the Cultitiller rotor provides superior performance in diversified conditions such as wet, sticky soils, higher residue and trash conditions.

## QUICK-RELEASE SYSTEMS: Because time is money



### EXCLUSIVE

#### FAST-FIT® ON CULTITILLER

This quick-release blade system is exclusively available by Kuhn. Each blade is secured with a linchpin. The scabbard type fit holds them in place. In this way, all blades can be replaced in just a few minutes.

#### SIMPLIFIED ROTOR REMOVAL AND REPLACEMENT

Both ends of the rotor are secured in keystone mounts. This provides rapid removal and self-aligning reinstallation. Thus, you can quickly replace the complete rotor or facilitate the tool exchange on a dismantled rotor. This is especially useful for commercial operations with small tillage windows.



#### CULTILOW: EASY-FIT

On Cultilow models, the Easy-Fit quick-release is the system of choice to make your life easier. Each blade can be removed and reinstalled by loosening and tightening only one attachment bolt.



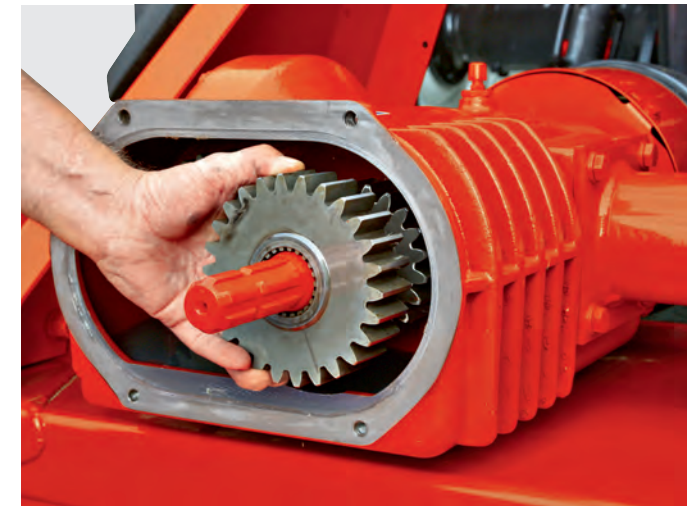

### DUPLEX GEARBOX: FLEXIBILITY FOR DIFFERENT SOIL CONDITIONS

Designed for heavy-duty applications, the gearbox is capable of handling powerful tractors. Thanks to the invertible gear sets, the rotor speed can be quickly adapted to obtain the required result: an adequate crumbling whatever the soil type is, light or hard. To offer a larger range of speeds, standard gear sets as well as optional gears are available. A rear PTO stubshaft is available as standard, which enables power to be transmitted to other implements fitted to the tiller.

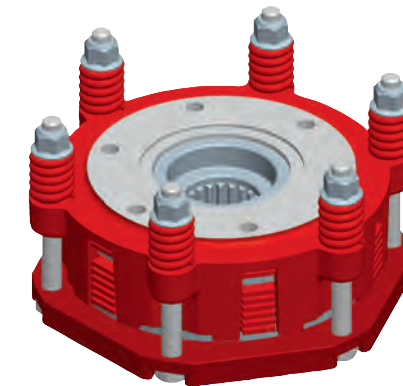

### EFFECTIVE DRIVELINE PROTECTION

All models feature a torque limiting slip clutch with adjustable settings that protect driveline components from shock and excessive loads.

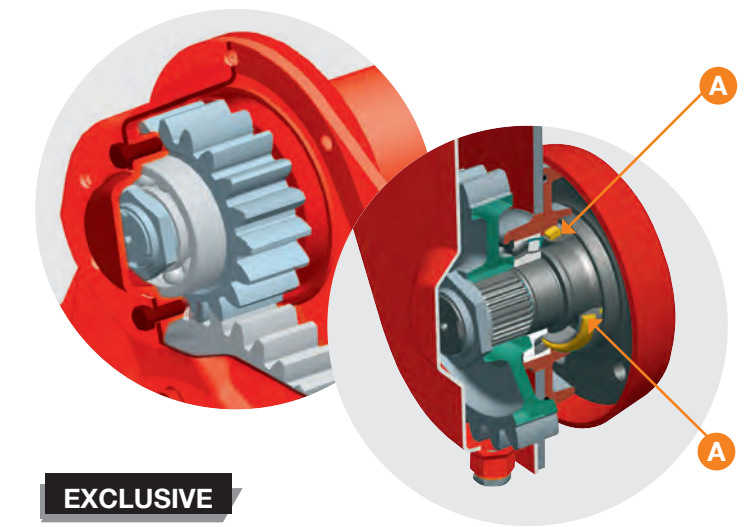

### EXCLUSIVE

### A FULLY RELIABLE ROTOR DRIVE

The power is transmitted to the large-diameter rotor through an all gear drive. Gears are made from case-hardened steel and run in an oil bath for an extremely long service life. The advantage: drive pinions are held in place **by bearings on both sides**, which provide improved support to the input pinion and maintain proper gear lash for excellent reliability. The rotor drive seal utilizes the most advanced sealing method available, a two-piece metallic face seal **A** for superior performance in difficult service applications.

POWER TILLERS EL 122 / 162

# DESIGNED FOR LONG LIFE AND SIMPLE OPERATION

EL 122 and EL 162 power tillers are intended for tractors rated at up to 125 hp and 165 hp respectively. As with all Kuhn implements intended for soil preparation, these power tillers feature a particularly sturdy design.

The one-piece frame, a two-speed gearbox, and the gear side drive meet the most stringent reliability requirements.

They are designed for convenient operation, with extremely quick and easy to perform adjustments.



### A HITCH FRAME THAT LASTS

A strong build makes the hitch frame very resistant to wear and shocks. The multiple position and telescopic coupling points adapt well to various tractors.

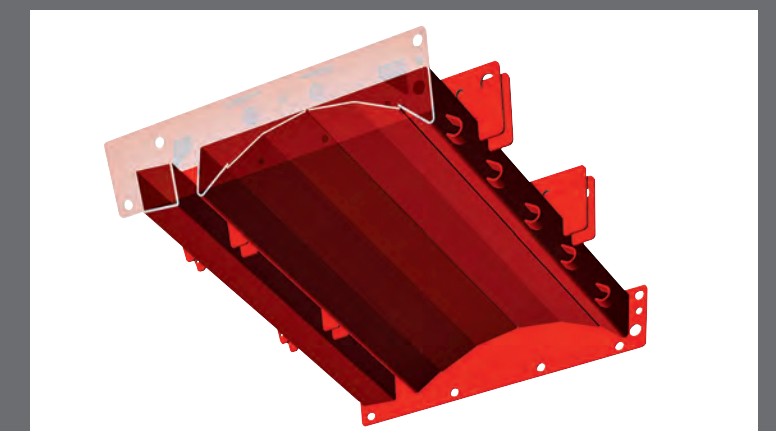

### A SOLID BOX FRAME

The heavy-gauge box section cross member acts as a one-piece frame. This offers improved rigidity even in the most difficult conditions. In rocky conditions, the machine's outer appearance is protected due to the double skin hood.



Adapted for intensive use under difficult conditions with high-power tractors...

POWER TILLERS EL 282

# COMMERCIAL GRADE TOUGH

Designed for difficult tillage operations on high power tractors up to 270 hp, these tillers are tailored for intense crop and field vegetable farms. Outstanding features of the EL 282, including a durable frame and chassis, innovative drivetrain and easy adjustments and maintenance, make it an all-purpose tool for operators who require the most from a high-horsepower tiller, hour after hour, day after day.

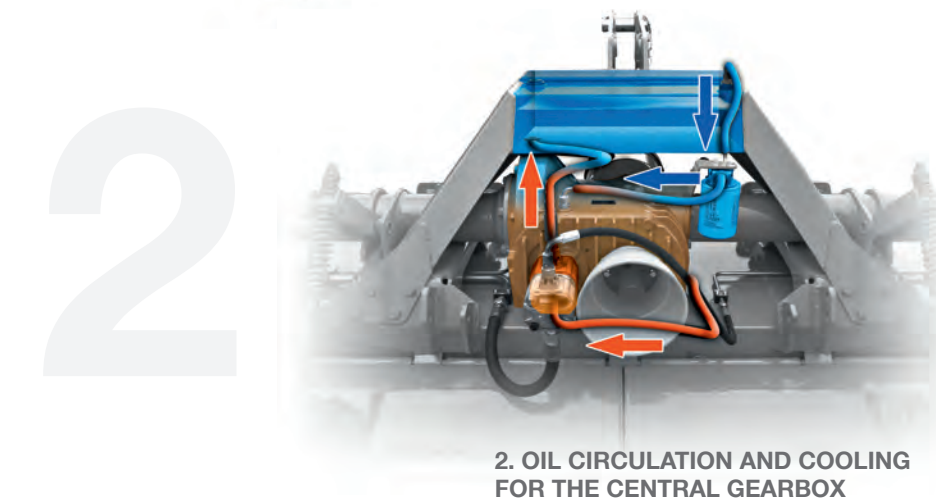
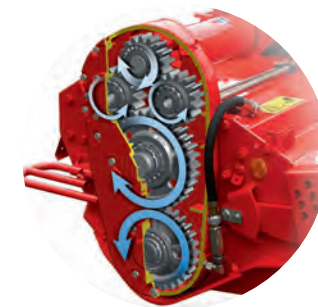
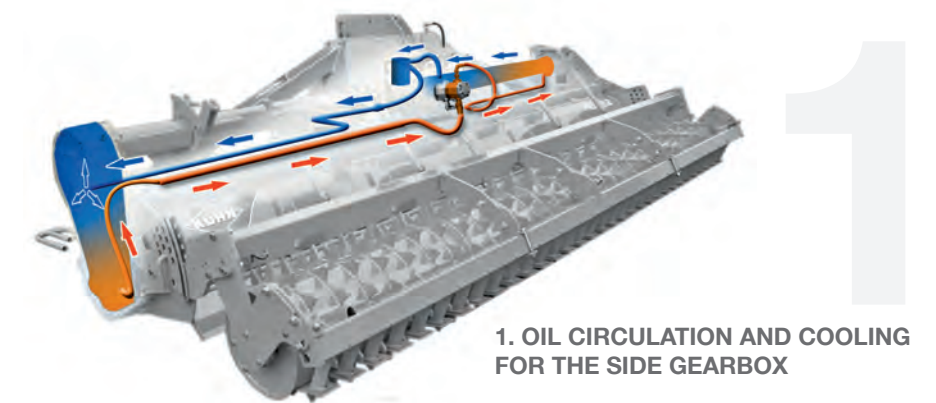

## EXCLUSIVE AN UNRIVALED SIDE GEARBOX

- All pinions in the gearbox are supported on both sides by tapered roller bearings
- The large gear profile used is unrivaled in the industry
- The double drive (design similar to the planetary gear train) ensures a smoother and more efficient drive than with two individual gearboxes: an exclusive Kuhn feature
- An integrated pump for oil circulation ensures both gearwheel lubrication and gearbox cooling. The large oil tank surface allows efficient evacuation of calories without requiring a delicate radiator and fan system that could easily become clogged
- High performance sealing: the rotor drive flange is fitted with the best sealing system available, a metallic face seal for unequaled performance and long life

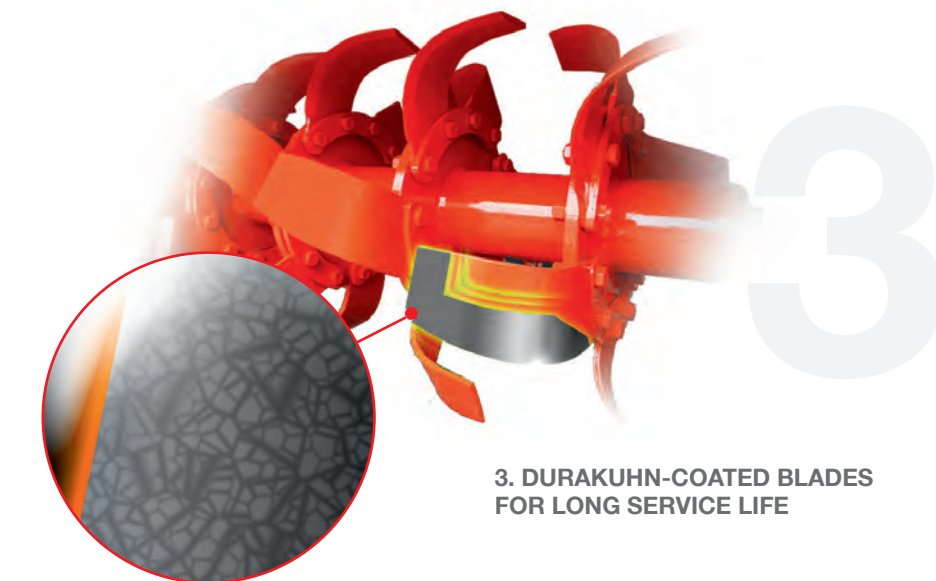

### HIGH-CAPACITY HEADSTOCK

The robust hitch frame is designed for intensive use. Side struts reinforce the framework on machines more than 9'10" wide. The linkage is designed for Cat. 3 and 4 tractors as well as for Cat. 3 and 4 quick hitches.

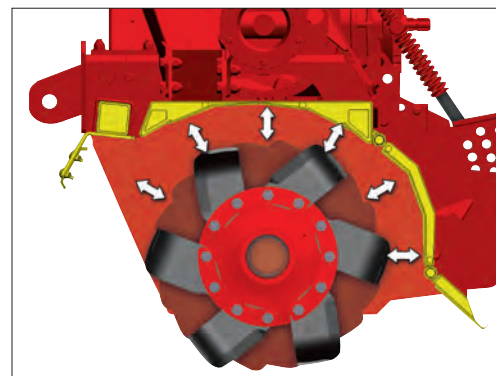

### LARGE ROTOR CLEARANCE

The significant clearance between the rotor and casing reduces power requirements and facilitates soil flow. In wet conditions, the machine has less tendency for power robbing soil build up to occur between the rotor and the body.

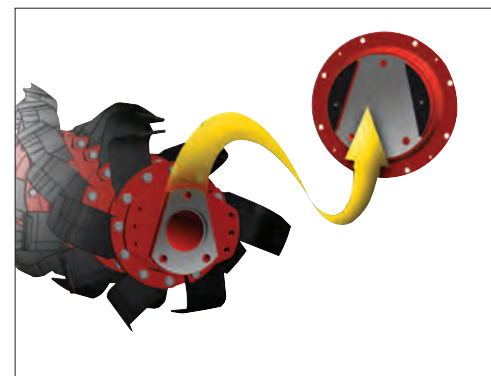

### RAPID ROTOR REPLACEMENT

The EL 282 tillers are fitted with Kuhn's exclusive quick change rotor system, which provides:

- Rapid exchange between the Cultirotor rotor and the Cultitiller rotor
- Safe blade replacement by separating the rotor from the chassis. It takes just a few minutes to remove the five mounting bolts and then the rotor is on the ground!

# OPTIONAL EQUIPMENT

In order to achieve the soil preparation needs in various situations, Kuhn power tillers are offered with a choice of different depth-control options. Easy adjustment of the roller position provides fine-tuning capabilities to maximize the effects of soil preparation.

Note: All depth control options noted may not be available for all machines. See chart on next page for more information.



## DEPTH AND ROLLER ADJUSTMENT

When fitted with a roller, depth adjustment is easily performed using pins inserted into a multi-hole quadrant. The roller is free to drop, maintaining maximum contact with the soil in any condition. This provides optimum firming of the seedbed and helps level the cultivated surface.



## REAR WHEELS

For work at shallow depth (pasture reclamation, stubble clearing), the rear wheels can replace the roller. In transport position, these wheels are pivoted to the inside to reduce the machine width.



## SKIDS OR FRONT WHEELS

These wheels are intended for work not requiring the surface to be entirely uniform. The front wheels are adjustable in spacing and will roll over firm soil without leaving tracks in the worked soil.

# ROLLER OPTIONS

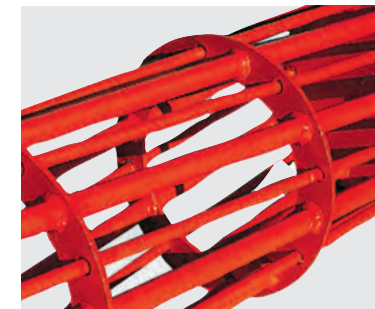

## CRUMBLER ROLLER

This type of roller, smaller in diameter 15.4" (390 mm) than the Maxicrumbler, is suitable for use on dry, non-sticky soils without an integrated seed drill. The removable rods can be withdrawn, if required, to reduce clogging risks. Maintenance requirements are minimal.



## MAXICRUMBLER ROLLER

The large 20" (520 mm) diameter of the Maxicrumbler roller provides reduced rolling resistance and good depth control in dry, non-sticky soils without an integrated seed drill.

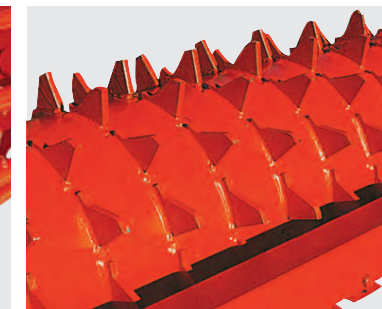

## PACKER / PACKER 2 ROLLER

This roller of 20" (520 mm) diameter is suitable for a wide range of soil conditions and especially recommended for clay soils that tend to skin and harden while drying. They contribute to an optimum seedbed by uniformly firming the soil while leaving loose soil on top. Suitable for use with lighter integrated drills.

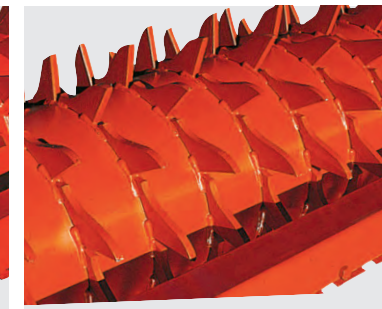

## MAXIPACKER ROLLER

The large 21" (535 mm) MaxiPacker roller diameter reduces the rolling resistance and increases flotation. This roller can easily be combined with heavier drills. Coated scrapers are supplied as standard to maximize the service life, reduce adjustment and improve cleaning of the roller in sticky soils.

	CRUMBLER ROLLER	MAXICRUMBLER ROLLER	PACKER	PACKER 2 ROLLER	MAXIPACKER ROLLER
<b>MODELS</b>					
EL 82-180	◆	-	-	-	-
EL 82-205	◆	-	◆	-	-
EL 92-180	◆	-	-	-	-
EL 92-205	◆	-	◆	-	-
EL 92-230	◆	-	◆	-	-
EL 122-250	◆	◆	◆	-	◆
EL 122-300	◆	◆	-	◆	◆
EL 162-250	◆	◆	◆	-	◆
EL 162-300	◆	◆	-	◆	◆
EL 282-300	-	-	-	-	◆
EL 282-400	-	-	-	-	◆
EL 282-450	-	-	-	-	◆

◆ = Rollers possible to attach

Please note the following machines do not have a roller option available: EL 23 Series, EL 43 Series, EL 53 Series, EL 62 Series, EL 82-130, EL 82-155.

**Model Specifications**

	EL 23-120	EL 23-150	EL 43-105	EL 43-130	EL 43-150	EL 43-190	EL 53-100	EL 53-130	EL 53-155	EL 53-190	EL 62-130	EL 62-155	EL 62-165	EL 62-180	EL 62-210
<b>DIMENSIONS</b>															
Working Width	49" (125 cm)	57" (145 cm)	42" (107 cm)	50" (127 cm)	58" (147 cm)	74" (188 cm)	38" (97 cm)	50" (127 cm)	60" (152 cm)	74" (188 cm)	50" (127 cm)	60" (152 cm)	65" (165 cm)	70" (178 cm)	83" (211 cm)
Overall Width	55" (139 cm)	63" (160 cm)	47" (119 cm)	55" (140 cm)	64" (163 cm)	80" (203 cm)	44" (112 cm)	56" (142 cm)	66" (162 cm)	80" (203 cm)	55" (140 cm)	65" (165 cm)	69" (175 cm)	74" (188 cm)	87" (221 cm)
Maximum Tractor PTO	25 hp (19 kW)		40 hp (30 kW)				50 hp (37 kW)				65 hp (48 kW)				
3-Point Attachment	Cat. 1 Standard (Cat. 0 is Possible)		Cat. 1				Cat. 1 and 1N				Cat. 1, 1N and 2				
Quick Hitch Compatible (with Optional Adapter)	Cat. 1														
Progressive Offset to the Right	Up to 4" (10 cm)		Up to 8" (20 cm)	Up to 12" (30 cm)	Up to 16" (41 cm)	-	6" (15 cm)	12" (30 cm)		-	8" (20 cm)			-	
Number of Blades Per Flange	4		4 (6 Possible)				6								
Number of Flanges	6	7	5	6	7	9	4	5	6	8	5	6		7	9
Number of Blades	24	28	20	24	28	36	24	30	36	48	30	36	42		54
Standard Rotor Speed	241 rpm		211 rpm				244 rpm				224 rpm				
Rotor Diameter (C-Blade)	15" (38 cm)					17" (43 cm)				18" (46 cm)					
Maximum Working Depth	4" (10 cm)		6" (15 cm)				Standard					7" (18 cm)			
Supporting Frame	-														
Adjustable Rear Hood	Standard														
PTO Speed	540 rpm														
PTO Shaft	Standard 1 3/8" - 6-Spline														
PTO with Slip Clutch Protection	Standard														
Type of Slide Drive	#60 Chain		#80 Chain				# 80-HV Chain				Gear				
Depth Wheels	-		Optional				Standard								
Adjustable Skids	Standard														
Machine Net Weight (Cultitiller)	317 lbs. (144 kg)	348 lbs. (158 kg)	464 lbs. (210 kg)	496 lbs. (224 kg)	529 lbs. (240 kg)	585 lbs. (265 kg)	550 lbs. (249 kg)	605 lbs. (274 kg)	649 lbs. (294 kg)	726 lbs. (329 kg)	650 lbs. (295 kg)	729 lbs. (330 kg)	793 lbs. (360 kg)	808 lbs. (367 kg)	925 lbs. (420 kg)

	EL 82-130	EL 82-155	EL 82-180	EL 82-205	EL 92-180	EL 92-205	EL 92-230	EL 122-250	EL 122-300	EL 162-250	EL 162-300	EL 282-300	EL 282-400	EL 282 450	
<b>DIMENSIONS</b>															
Working Width	51" (130 cm)	61" (155 cm)	71" (180 cm)	81" (206 cm)	71" (180 cm)	81" (206 cm)	91" (231 cm)	8'2" (2.5 m)	9'10" (3 m)	8'2" (2.5 m)	9'10" (3 m)		13' (4 m)	15' (4.5 m)	
Overall Width	66" (168 cm)	76" (193 cm)	85" (216 cm)	98" (249 cm)	85" (216 cm)	98" (249 cm)	109" (277 cm)	9'1" (2.8 m)	10'8" (3.3 m)	9'1" (2.8 m)	10'8" (3.3 m)	10'9" (3.3 m)	14'2" (4.3 m)	15'7" (4.8 m)	
Maximum Tractor PTO	85 hp (63 kW)				100 hp (75 kW)			125 hp (93 kW)		165 hp		270 hp			
3-Point Attachment	Cat. 1, 1N and 2				Cat. 1 and 2			Cat. 2		Cat. 2		Cat. 3 and 4			
Quick Hitch Compatible	-														
Progressive Offset to the Right	8" (20 cm)			-	4" (10 cm)		-								
Number of Blades Per Flange	6						6								
Number of Flanges	5	6	7	8	7	8	9	-							
C-Blade Rotor	30	36	42	48	42	48	54	60	72	60	72		96	108	
Cultiplow Rotor with Angled Blades	-						84	100	84	100	-				
Cultitiller Rotor with Angled Blades	-						56	66	56	66	60	80	94		
Standard Rotor Speed	212 rpm				Std. 194 & 230 rpm - Opt. 178 & 252 rpm			Std. 218 rpm		236 rpm		244 / 287 rpm			
Rotor Diameter (C-Blade)	21" (53 cm)						21" (53 cm)			21.7" (55 cm)		24.3" (62 cm)			
Maximum Working Depth	9" (23 cm)						Standard			10" (25.5 cm)		11" (28 cm)			
Supporting Frame	Standard														
Adjustable Rear Hood	Standard														
PTO Speed	540 rpm						540 / 750 / 1,000 rpm			750 / 1,000 rpm					
PTO Shaft	Standard 1 3/8" - 6-Spline						1 3/8" 21-Spline at 1,000 rpm			Supplied with yoke for 1 3/4" - 20-spline PTO ( 1 3/8" - 21-spline PTO yoke is available through the Kuhn Parts Department)					
PTO with Slip Clutch Protection	Standard														
Type of Slide Drive	Gear														
Depth Wheels	Standard						Optional			Optional					
Adjustable Skids	Optional						Optional			-					
Machine Net Weight (Cultitiller)*	870 lbs. (395 kg)	948 lbs. (430 kg)	1,025 lbs. (465 kg)	1,124 lbs. (510 kg)	1,157 lbs. (525 kg)	1,256 lbs. (570 kg)	1,333 lbs. (605 kg)	2,414 lbs. (1,095 kg)	2,677 lbs. (1,214 kg)	2,509 lbs. (1,138 kg)	2,876 lbs. (1,305 kg)	4,519 lbs. (2,050 kg)	5,512 lbs. (2,500 kg)	6,008 lbs. (2,725 kg)	

\*For additional roller weights, please contact your dealer.

# COMPLEMENTARY PRODUCTS

## MORE PRODUCTS TO MEET YOUR NEEDS

With over 700 models of equipment, we have the most complete implement line in the industry. Whether you have a small or large operation, we have a broad range of models and options to help fit your diverse needs.



1. Rollover Plows
2. Power Harrows
3. Combo Discs/ Shanks
4. Fertilizer Spreaders
5. Mounted Mechanical Grain Drills
6. Trailed Grain Drills

For more information about your nearest Kuhn dealer and other Kuhn products, visit our website at

[www.KuhnNorthAmerica.com](http://www.KuhnNorthAmerica.com)



Visit our YouTube channel to watch our latest product videos.

### KUHN NORTH AMERICA, INC.

Corporate Headquarters  
1501 West Seventh Avenue - Brodhead, WI 53520  
Phone: (608) 897-2131 Fax: (608) 897-2561

Our machines comply with the North American safety regulations. In our leaflets, to better illustrate certain details of the machines some safety devices could have been removed. Conforming to the assembly and operator's manual, in no circumstances must machine be operated without these safety devices in place. All machines are equipped with safety devices which comply with the regulations of the countries in which they are delivered. In the interest of progress, we reserve the right to change without notice any specifications, design or materials listed. Patents filed in several countries.

Your Kuhn dealer



[www.KuhnNorthAmerica.com](http://www.KuhnNorthAmerica.com)

Find us on

